



Considerations for Assessing Mounting Needs



Optimal Device Positioning



Optimizing Device Positioning

“Optimal” varies (consider the whole picture)

- From person to person
- Their needs and specific considerations
- Impacts access, mobility, health, independence

Holistic approach

- Accommodate different devices and activities
- Multiple devices (concurrent access)
- Different operating positions
- Across environments (bed, w/c, table, work)

Needs assessment: Ask questions and consider the possibilities

Needs identification

- What do they need/want to access?
- Where do they need it?
- What else do they want to do?(no need to limit them to 1 device)
- How do they currently address this need?
- What is/isn't working for them?
- Do they need to remove their mount/device?
- Describe your ideal set-up

What to Mount

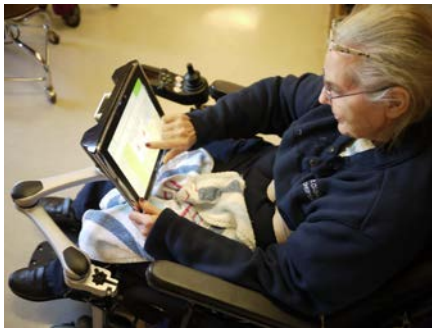

Communication Devices



Technology



Other



Trays



Camera

Device & Tray Attachment Options



iTab Tray



12" x 12" Tray



Universal Rotator

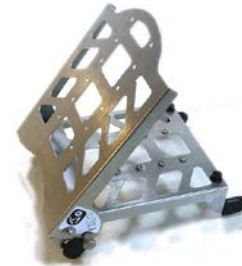

Stand +90



Camera



Laptop Tray



Tray with Lip



Phone



Tablet & Keyboard



Device Plates

Phone Mount

Otterbox Defender Swivel Case



Tablet Tray with Hinged Tray



Show with Surface tablet
and keyboard. Tray size:
12" x 9 1/2:"s

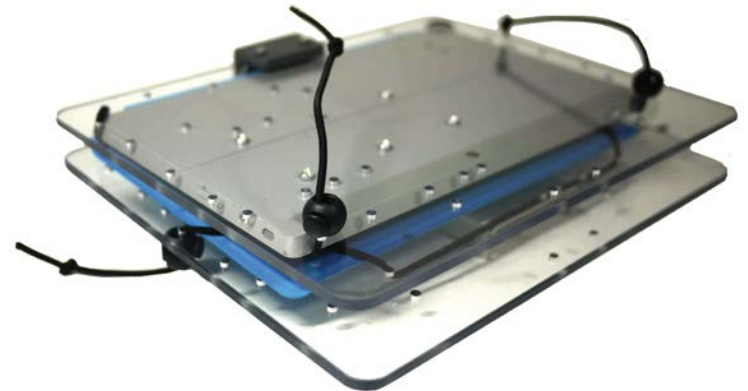

iTab Tray 12" x 9.5"



Tablet	Dimensions	Hole Use Config.
Amazon Kindle Fire HD 7"	7.50 x 5.4"	E
Amazon Kindle Fire HD 8.9"	9.4 x 6.4"	D
Amazon Kindle Fire HDX	7.3 x 5.0"	G
Amazon Kindle Fire HDX 8.9	9.1 x 6.2"	D
Asus Memo Pad HD7	7.7 x 4.7"	F
Asus Vivo Tab Note 8	8.75 x 5.25"	E
Apple iPad Air	9.4 x 6.6"	D
Apple iPad 2	9.7 x 7.31"	C
Apple iPad Mini and with Retina	7.87 x 5.3"	E
Dell Latitude 10	10.8 x 7"	B
Google Nexus 7	7.2 x 4.7"	F
Google Nexus 10	10.4 x 7"	B
HP ElitePad 1000 G2 Tablet	10.28 x 7.01"	B
Lenovo Idea Tab A2107	7.6 x 4.8"	F
LG G Pad 8.3	8.5 x 5"	E
Microsoft Surface Pro 2	10.81 x 6.81"	A
Microsoft Surface 2	10.81 x 6.77"	A
Samsung Galaxy Tab 2	7.5 x 4.8"	F
Samsung Galaxy Tab 2	10 x 7"	B
Samsung Galaxy Tab 3	7.4 x 4.3"	F
Samsung Galaxy Tab 3 (8")	8.2 x 4.8"	E
Samsung Galaxy Note 8.0	8.3 x 5.35"	E
Samsung Galaxy Note 10.1	10.11 x 6.9"	B
Sony Xperia and Tablet Z	10.4 x 7"	B

Key: Above Tray ————
 Below Tray - - - - -
 Cord Lock ———●———

iTablet Tray-Hole Use Configuration

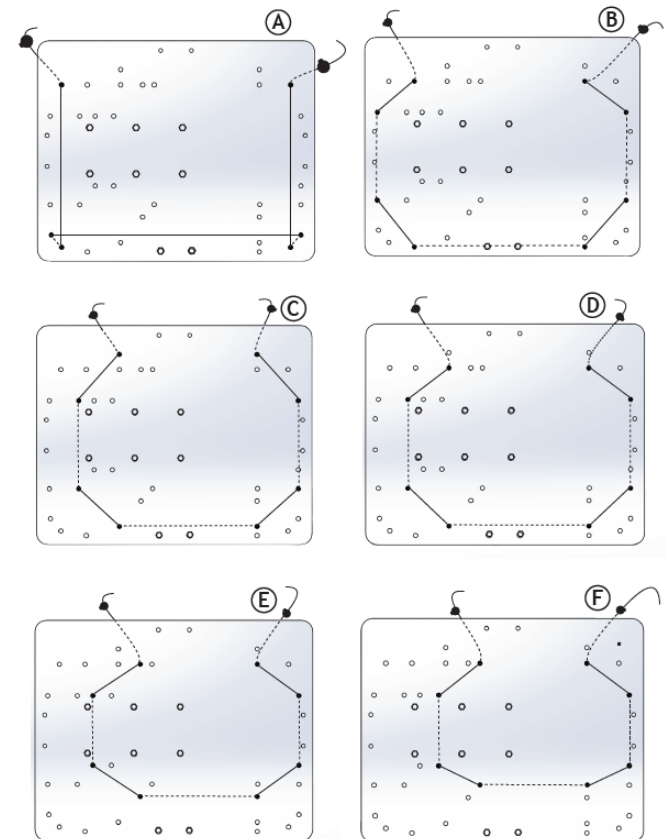

Custom Trays Available



Device Attachment Options

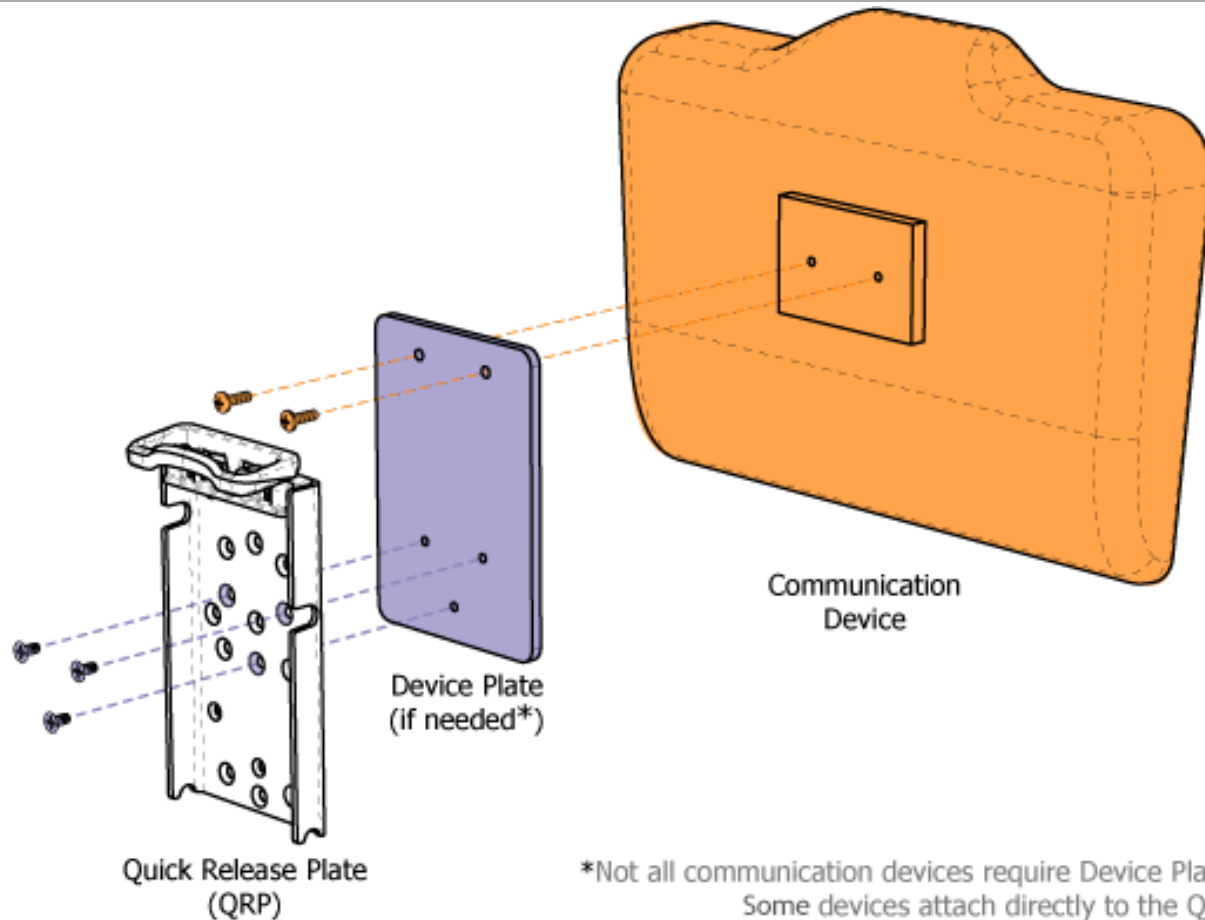

*Not all communication devices require Device Plate. Some devices attach directly to the QRP

AAC Device Plates

Find the attachment plate for your device

MAKE	MODEL	PLATE
Tobii Dynavox	Maestro, T10, T15, V, Vmax, M3, DV4, MT4	DP-DV1
	EyeMax, Maestro w/eye gaze	DP-DV2
	EyeMobile, C15 (contact us for C15 with eyegaze)	DP-MULTI1
	T 7	Contact Us
	P10, C8, C12, CEye, S32,	DP-T1
	I-Series	DP-T2
Prentke Romich Co.	Accent 800	QRP or DP-PRC4*
	Accent 1000	DP-PRC5
	Accent 1400, ECO2, ECOpoint, ECO-14, Vanguard, Pathfinder 2	DP-PRC1
	Accent 1200, Vantage Lite, Springboard Lite	DP-PRC4 *
Saltillo	NOVA chat (requires wheelchair mounting plate)	DP-PRC4 *
Others	(Jabbla)-Mobi/Tellus, (Abilia)-Rolltalk, AMDI, VESA (50,75,100mm), Smartbox	DP-MULTI1
iPad/Tablets	Fits most iPads / Tablets	TR-iTab,-UR

Plates for AbleNet, Lightwriter and more are available. See website for specifics

* DP-PRC4 plate requires a QRM mounting bracket from Prentke Romich Co.



Where to Mount

Wheelchair



Standers

Strollers



Where to Mount



Wall



Floor Stand

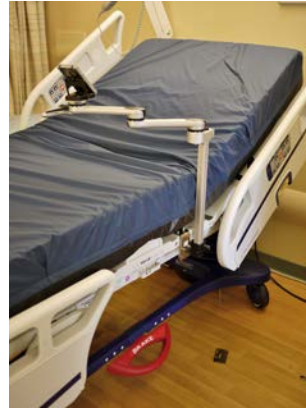

Bed



Walkers



Table

Table Mounts

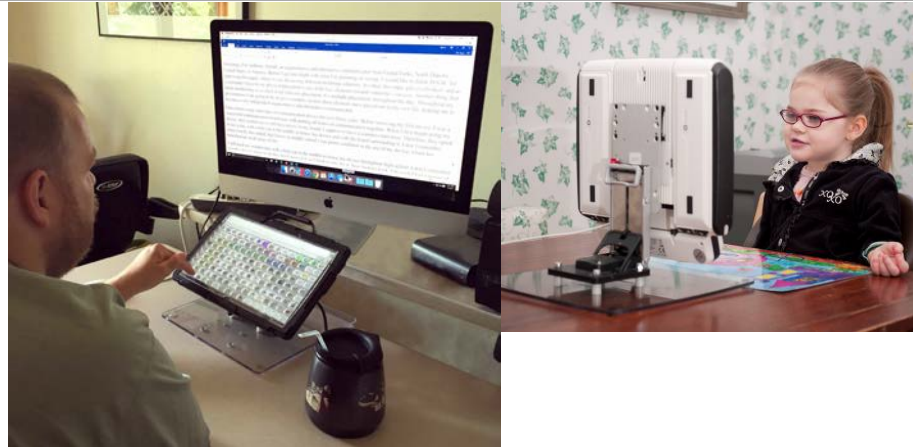
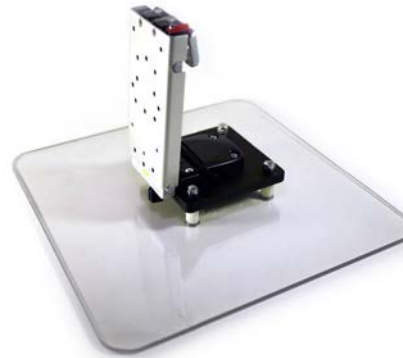
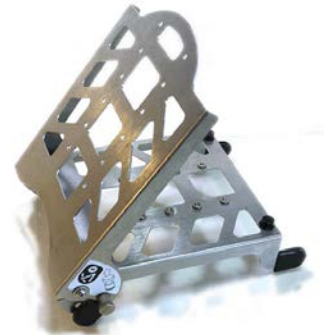

Table Clamp



Mount'n Tilter



Stand +90

What is available?

Light duty

Static/Rigid (not movable)

Somewhat movable

- Out of position to nonfunctional positions
- May or may not move it independently
- Daessy Swing-Away; Connect-it

Very movable

- Independently
- To more than one functional position

Rigid Mounts

Examples of rigid mounts are simple bars attached to the wheelchair with a plate for the device, the bar may swing away or not.

Shown below is a common rigid mount that swings away, but has limited adjustment



Daessy Folding Mount



Rigid Mounts

Does the user's device or condition require a mount that can support heavy weights?
(Greater than 15 lbs?)

Does the user or caregiver need a mount that is in one or two positions at all times?
(a use position and a transfer position)

Does care staff change frequently?

If YES consider a more rigid mount

Static vs. Movable

Static Mount

- Impede transfers
- Obstructs vision
- Single operating position
- Most can not be moved independently



Movable Mount

- Move independently
- Set multiple lock positions, changes with ability
- Safety - visual or physical access, reduce tipping hazard
- Use multiple devices



Movable Mounts

Examples of adjustable mounts are arms attached to the wheelchair with a plate for the device or a tray that have many adjustments

Shown here is a common adjustable mount that has wide adjustability



How Does It Differ?

Independent repositioning where possible

Easier repositioning by others, locks provide consistent positioning

Enhanced independence & functionality in

- transfers
- eating
- toileting
- device use
- driving

Set one OR MORE locked positions

Multiple devices

Safety - visual or physical access for: driving, emergency, restroom, reduce tipping hazard



One Mount - Many Uses

Moves easily from chair, bed, table, desk, and floor stand!

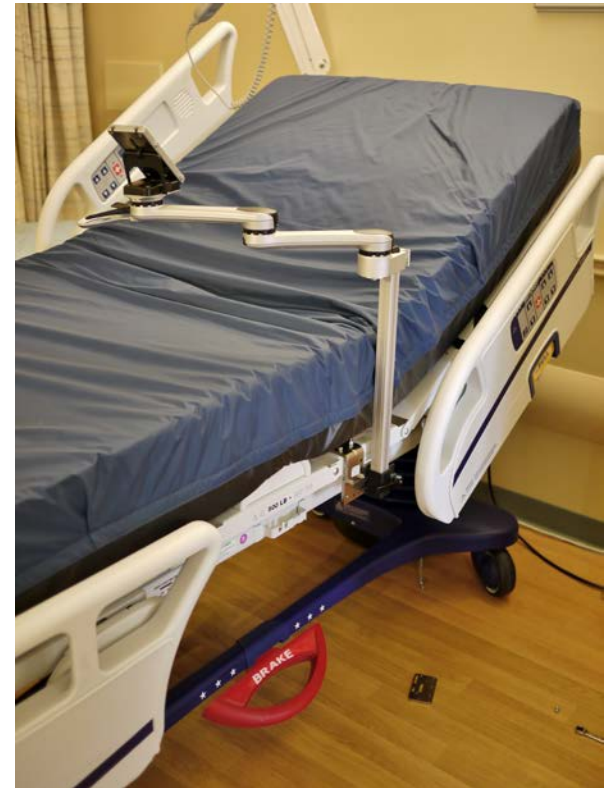

New Design Offers Enhanced Features

- ❖ Double custom locks from 12 to 24. 13,824 position!
- ❖ Increase forward tilt for eye gaze communicators
- ❖ Easier fine tuning for precise positioning
- ❖ Paddle and lever - improved ergonomics and strength
- ❖ New Post Cube - sleeker with more attachment options
- ❖ Black color - customize with color accents
- ❖ Quick Release Plate attaches/detaches easier, larger Red Lock tab



Options



Dual Arm



Single Arm



Tilt'n
Turner

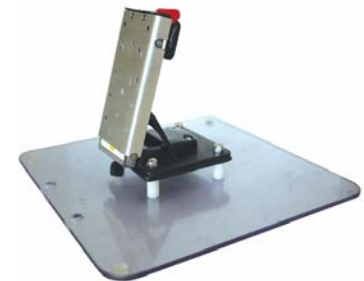

Mount'n Tilter

Moving The Arm

1. Press hoop. Unlocks both shoulder and elbow.
2. Move both arms at once. Use hoop to steer.
3. Let up on the hoop. Continue moving arms to find a memory lock position.

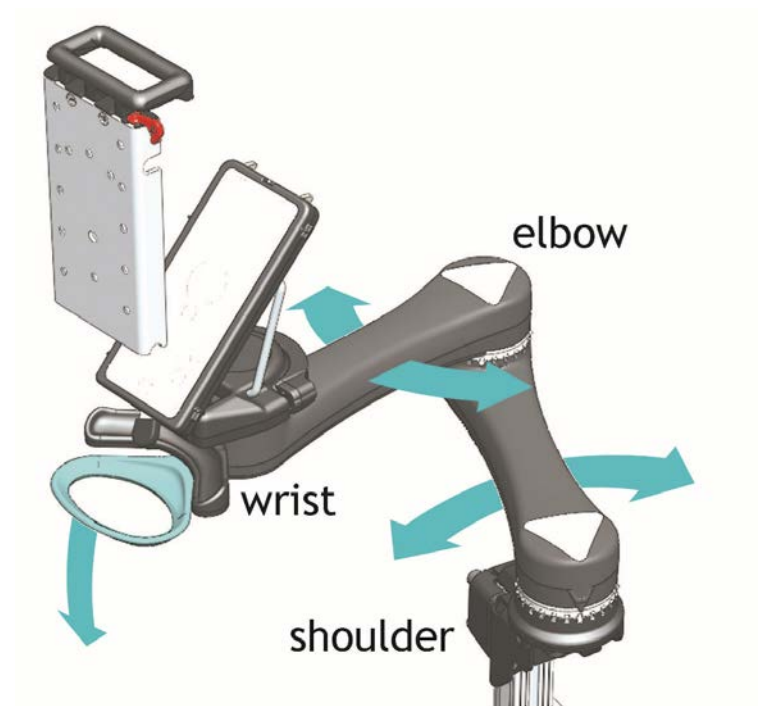

Rotate The Wrist

1. Press PADDLE to unlock wrist. Wrist is momentarily unlocked at that position.
2. Move it! Wrist will remain unlocked until it finds memory lock position.

One-handed operation!



Adjust The Tilt

1. **Unlock:** move tilt lever to the right.
2. **Adjust tilt angle:** push down or pull up on the device.
3. **Lock:** move tilt lever to the left.

High or Low resistance hinge available.

High resistance hinge recommended for large devices 5 pounds or heavier.

Slight forward tilt for eye gaze access

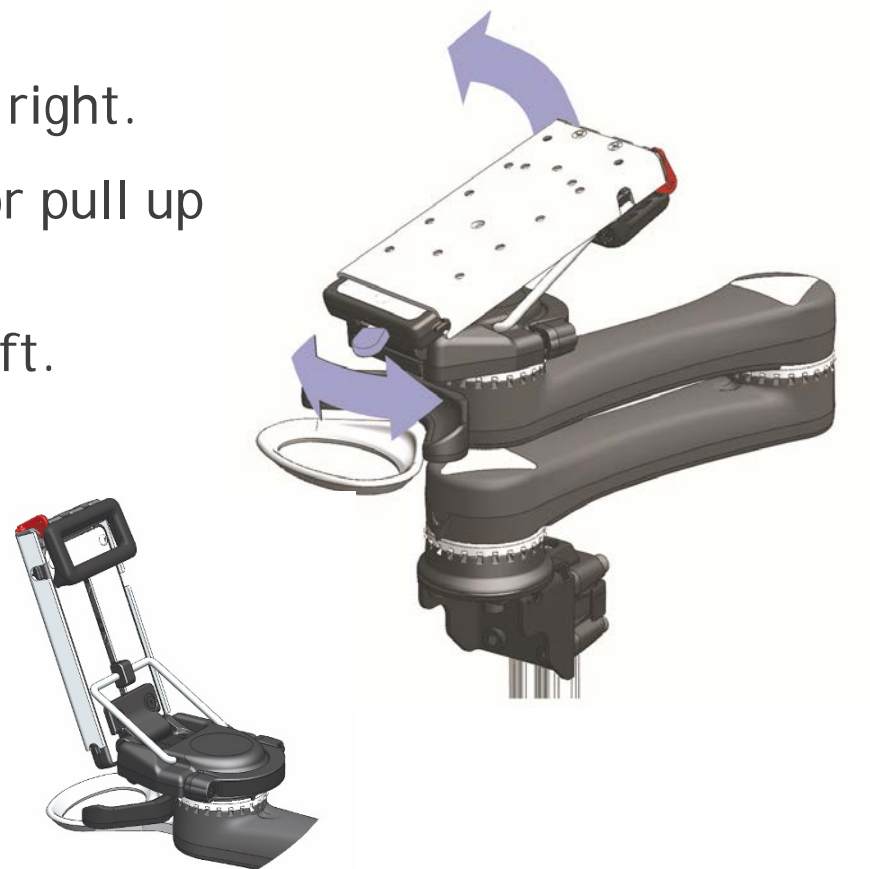

Quick Release Plate (QRP)

The QRP is needed to attach a device or tray to the Mount'n Mover.

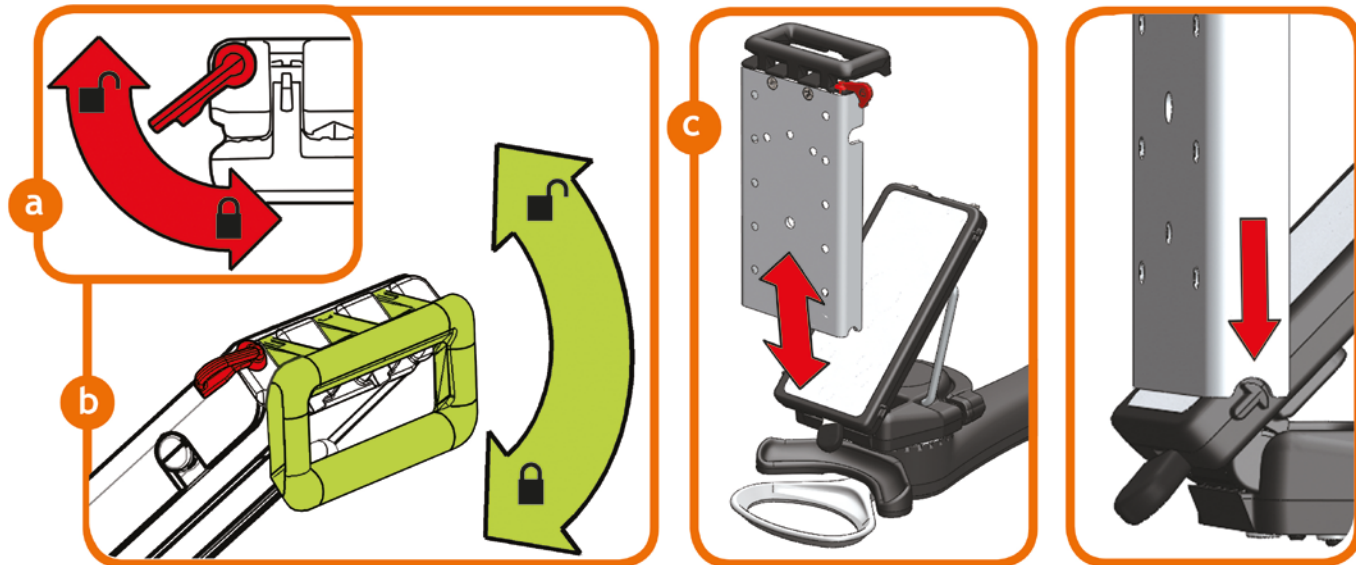

- a: Release “red lock” by rotating clockwise
- b: Unlock by pulling out + up on handle (highlighted green)
- c: Lift off by pulling forward and up

Reverse these steps to re-attach to device plate

Customize Lock Positions



To set one or more lock positions, push lock setter(s) down.
Up to unlock*.

**Setters can only flip up when NOT locked in position*

Getting Started

Determine the functional needs and desires to recommend the correct match between the person the assistive technology

Ask key questions to identify what features in a mount can aid in meeting those needs

Does the Mount Allow for a Variety of Adjustments?

Does it allow for a variety of adjustments to accommodate for change in positioning, growth, fatigue, or environment?



Adjustable Mount Tilts With Chair



Adjustable Rotation for Head Tilt

Rotation

- Communication device for head tilt and side-lying for eye gaze access
- iPads from landscape to portrait and back



Universal Rotator



Adjustable Visual Access and Standing

Moves to
side for
visual access



Access device
when standing

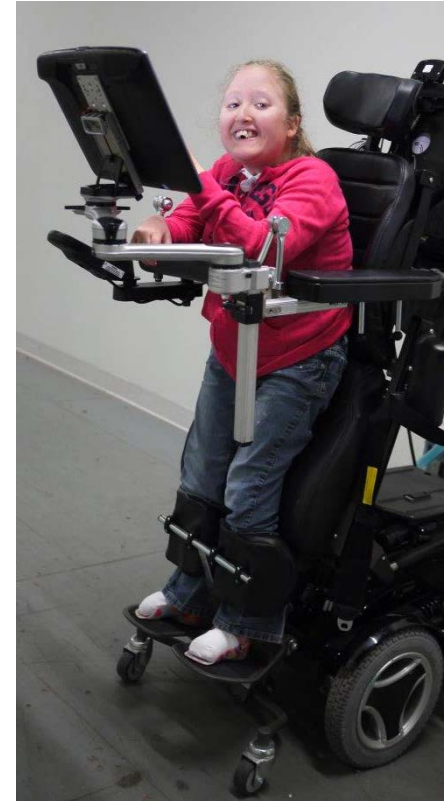

Adjustable Grows with Client

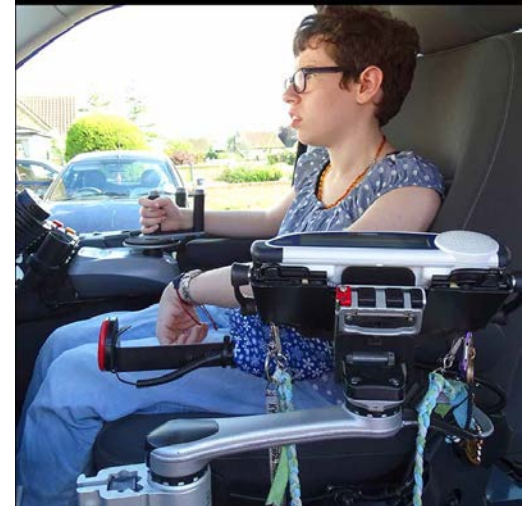

Tools for life!

Adjustable Environment



Move to the side for dining or to access from another chair



Adjustable Different Environments

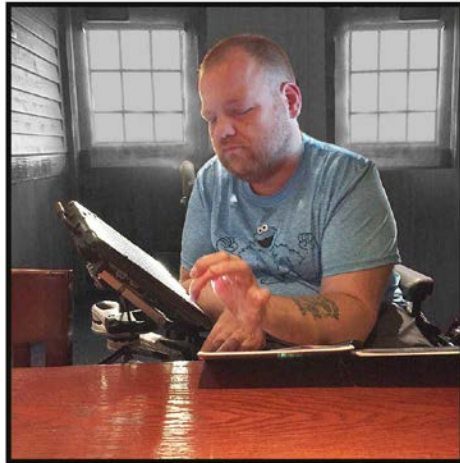

Moves to the side to pull up to the table, read menu, transfer, use restroom



Protects device when working out at the gym and allows him to communicate with personal Trainer

Can the Mount be used Independently by the User?

Reduces dependency on caregivers

Increased independence in performing functional skills like eating, writing and communicating

Provides access to device in case of an emergency

FREEDOM!



Independence Moves to Transfer



Gae moves her device to the side to transfer to her stair lift

Independence

Transfer from Chair to Bed

Life changing:

Ryan is no longer dependent on family members for removing device to transfer. He moves it to the side.



Independence Communication



“I like the new mount because I can eat and talk at the same time.”

~Bob

Can access device from two positions!

Independence Communication

Ryan programs his communication device, turns the screen to his friend to read his message for a private conversation

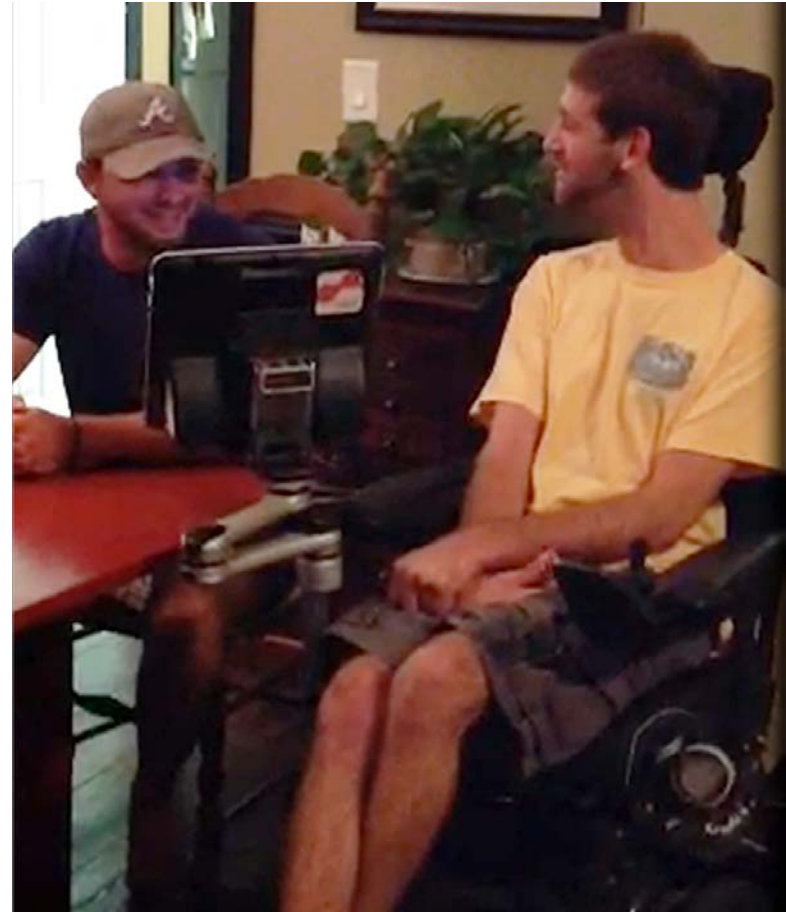

Do They Need to Access Multiple Items?

Do they have more than one item they need to access?

Do they want to mount two items at the same time?

Rosie

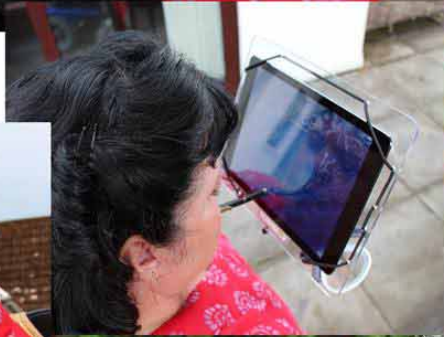
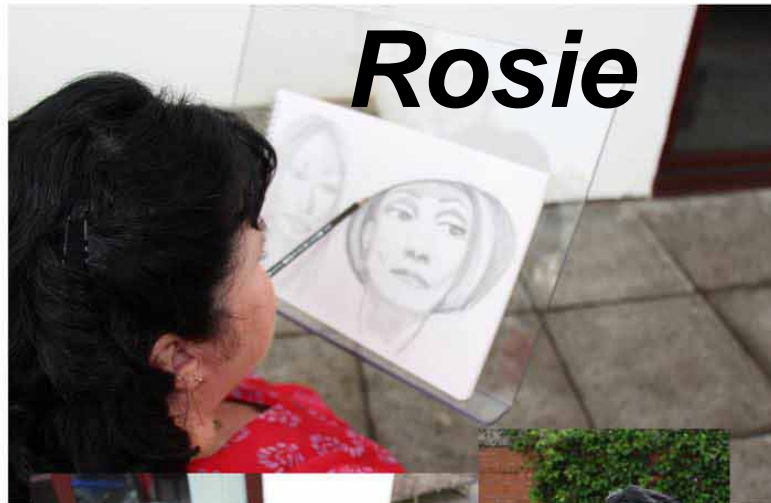

“Overcoming obstacles is the stuff of being a disabled person, and so when the mountain seems ever harder to climb, we look at ways of moving the mountain a little closer which, for most of us, means we can look at ways of making life easier in all kinds of different ways”.

“One of the things the Mount’n Mover does is give you back some of the spontaneity that life as a disabled person doesn’t always allow. With the Mount’n Mover the emphasis is very much on the product meeting the needs of the consumer”.

Rosie Moriarty-Simmonds OBE
Consultant, Writer, Artist,
Presenter, Photographer



<http://fourfingersandthirteentoed.wordpress.com/>

Copyright © 2014 by Rosaleen Moriarty-Simmonds, Photography by James Moriarty-Simmonds

Multiple Devices At the Same Time

As a college student Nicole needs to multitask: reading, writing, laptop

Solution:

Double Decker Mount

- Dual Arm, Laptop Tray
- Tilt'n Turner, Reading Tray
- One Post, w/c Hardware



Multiple Items One Tray - Multipurpose



Multi-tasking



Double Decker
Dual Arm and Tilt'n Turner

Offset Link Cube to allow lower placement on post for Double Decker

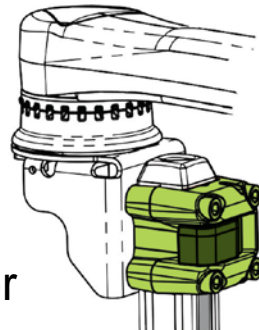

One tray holding 2 items

Meet Ian - Phone Mount & Tray



Multiple Devices with Dual Posts

Anthony wanted separate mounts for communication device and phone

Solution: Dual Posts, Dual Arm, Custom Plate for Phone



Multiple Devices with Dual Posts

Meet Brian

Film Maker

Two cameras for film making. Allows him to film himself and his subject.



Do They Need Multiple Operating Positions?

Can it provide multiple operating positions without the use of tools?

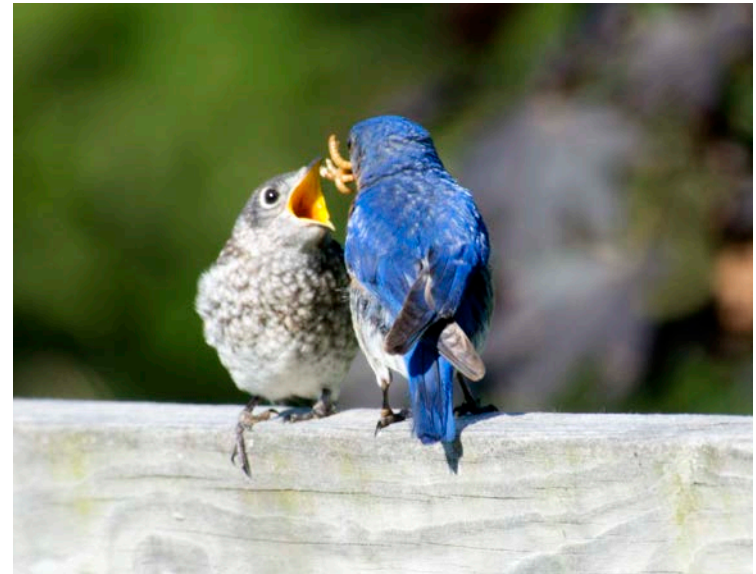

Operating Positions Adjustability

Attached to power chair
Allows camera to get close to eye
Rotation and tilt



Operating Positions

Unique Operating Position



Ergonomics

Varies per person's needs

Access to iPad

Mount is below seat level

Stabilizes arm on leg

Angled for access (Vis/Phys)

Access to computer table

Needs to move it to the side

Elevates herself to work on her computer

Operating Positions

Unique Operating Position



iPad mounted at seat level provided ability to stabilize arm for direct select access

Will the Client want Access in Multiple Locations?

Locations include chair, bed, table, desk, and wall

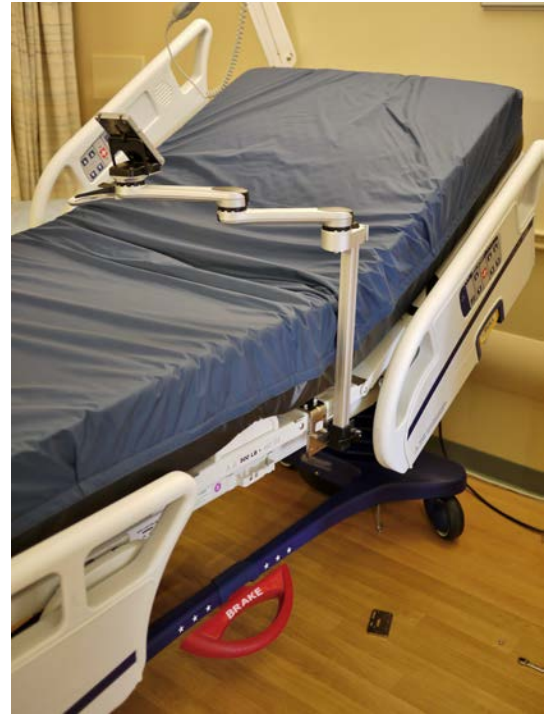

The same mount can be relocated eliminating the need for multiple mounts.

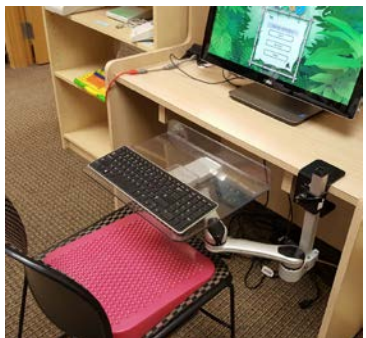

Ryan Carter



Tobii Dynavox Ambassador

Motivational Speaker

Life changing experience with AT

Needed mount that would facilitate safety, independence, transferring, communication at ALL times

Decrease need for assistance - freedom!!

Rotate Mount for Access out of the Chair

Uses chair as base

Can eliminate need for additional bed or table mount



Transfer from Chair to Bed



Is Access Method Eye Gaze or Head Tracker?

Positioning is critical

Consistent placement of device is essential



Eye Gaze Optimal Positioning



- Positioning is critical
- Easy calibration
- Need consistent placement of device
- As position changes throughout the day - so must the mount
- Tilt and rotation
- Easy for caregivers - multiple locked positions
- Moves from chair to bed, table, wall or floor stand

Eye Gaze Options



Universal Rotator

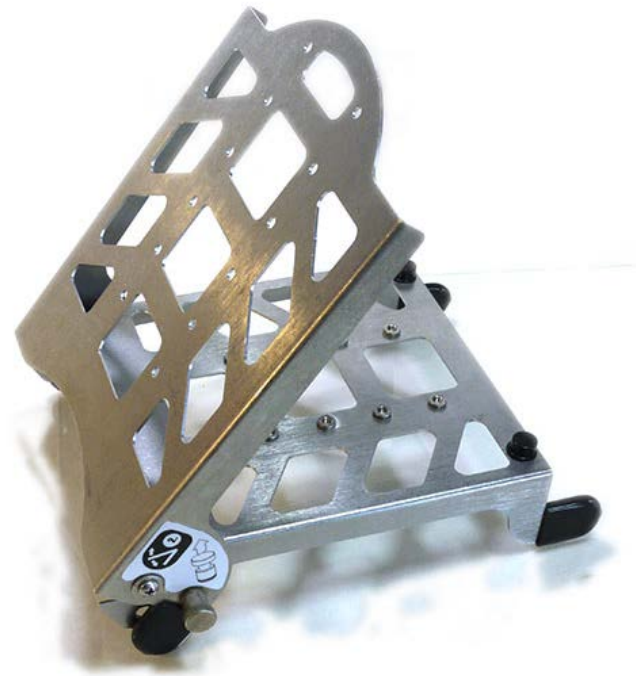

Stand+90

Stand +90

Combines two products in one!

- Additional 90 degrees of tilt for reclined access
- Use as a table stand

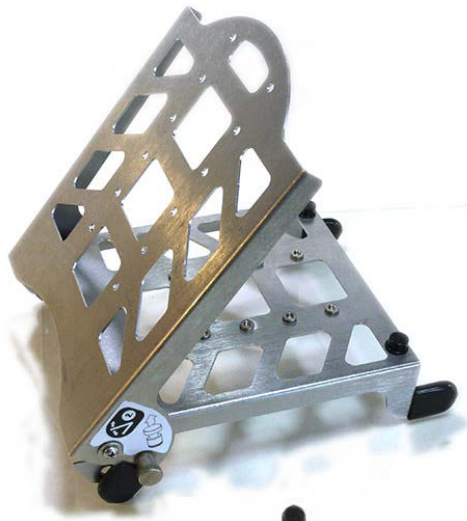

Downward Angle for Visual Access with Eye Gaze



Stand +90



Universal Rotator



Rotates

- Communication device for head tilt and side-lying for eye gaze access
- iPads from landscape to portrait and back

Stand+90 and Universal Rotator

Sophia needed to use eye gaze for access to her communication device while in bed and in her chair

Solution: Floor Stand, Dual Arm, Stand +90 with Universal Rotator



Move from Chair to Bed

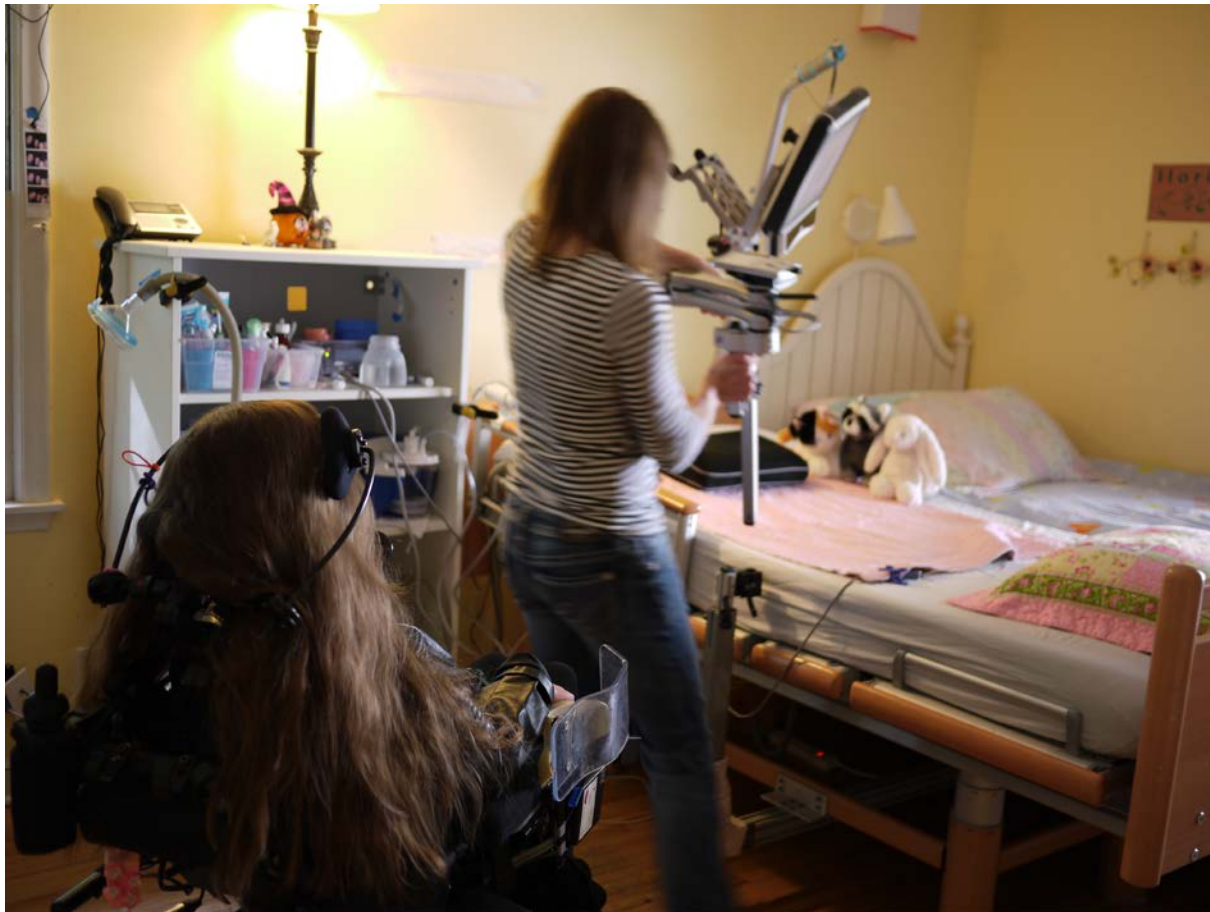









Video: Sophia and Her Mount'n Mover



https://www.youtube.com/watch?v=AGJK80_8jvM&feature=youtu.be

Eye Gaze



At home and school!

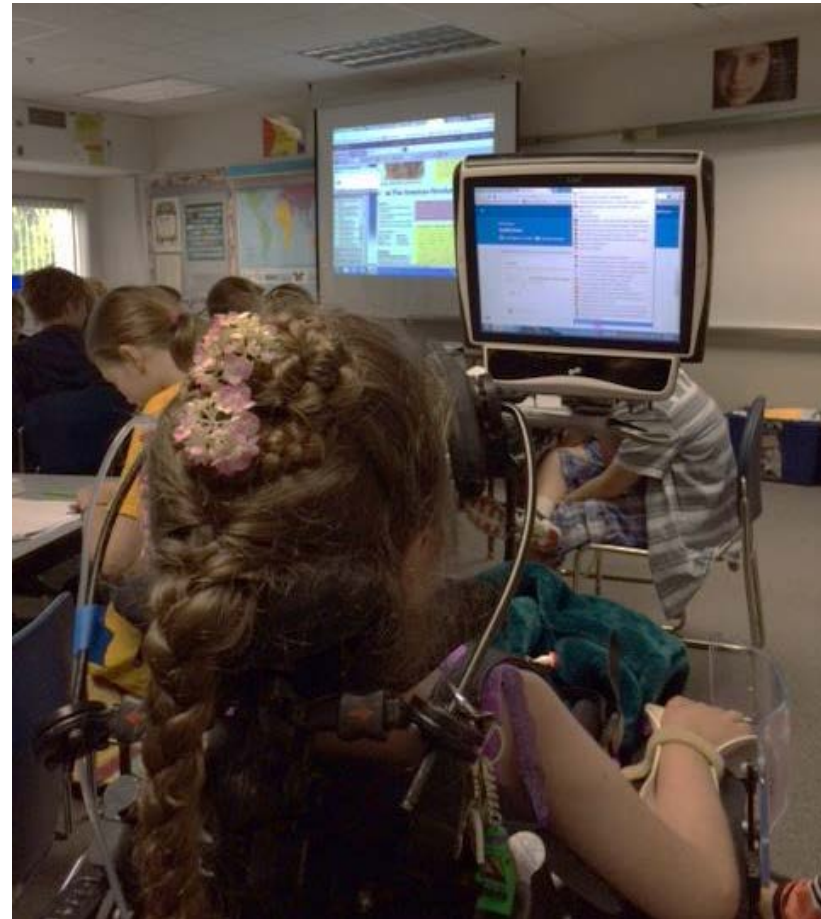

Special Education Classrooms

Virginia Beach City Public Schools

- 30 Mount'n Mover workstations in special education classrooms - uses floor stand for easy movement through the room
- Adjusts quickly for physical accommodation
- Elevated iPads position for small group instructions
- Access for all - lying on the floor and presenting
- Offer security to the devices - safe, less damage, protects investment

Head Tracker Technology

Gae uses a Surface Pro 2 Tablet with Tobii Communicate 4 software with head tracking technology

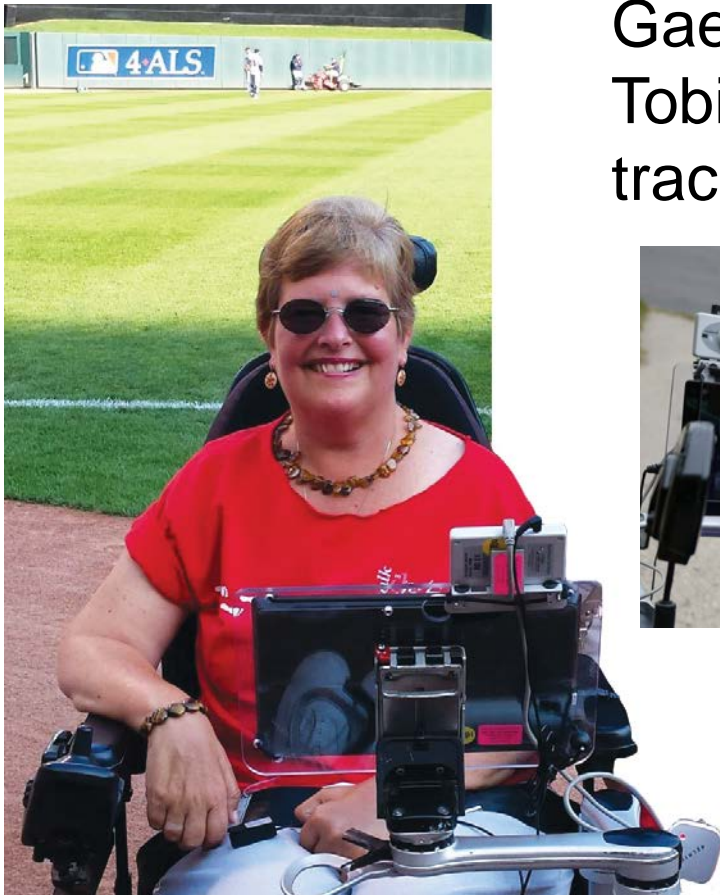

Benefits of a Movable Mount

Optimal positioning reduces fatigue due to ALS

Easier to transfer

Can rotate device to reboot or adjusts for glare

Visual access for driving, TV

Access to tables and sink

Move device to exercise her legs

Mount adapts to changing needs



Moves device to the side for photo

Video: Gae and her Mount'n Mover

See how Gae finds ways to preserve her independence while living with ALS

<https://www.youtube.com/watch?v=4RH5ljYnQjU>



Meet David

IT guy, ALS

Using eye gaze for
speech & computers

Wanted to improve the
technology

Goal: DJ a New Year's
Eve Dance



Wheelchair Access to Two Devices

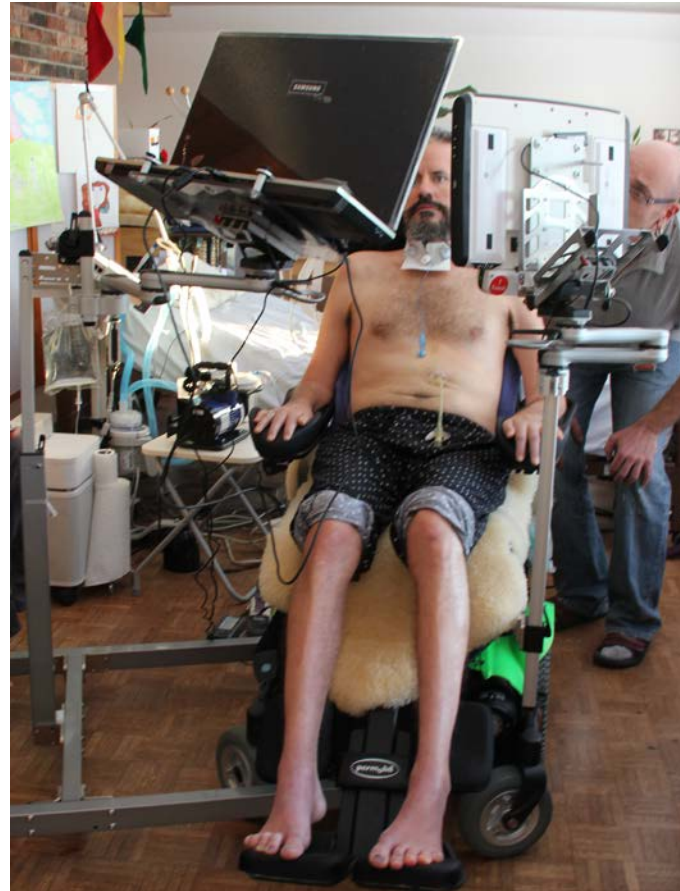
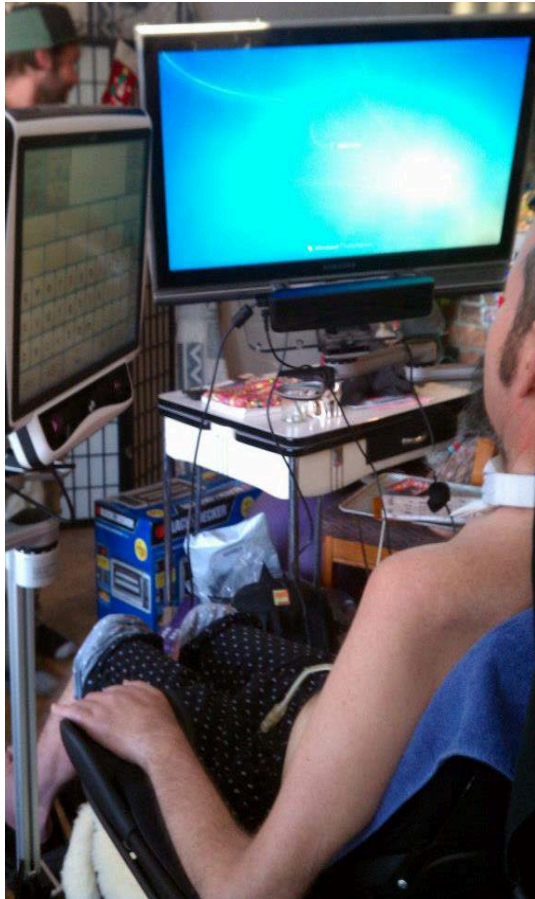

Bed Access - Floor Stand

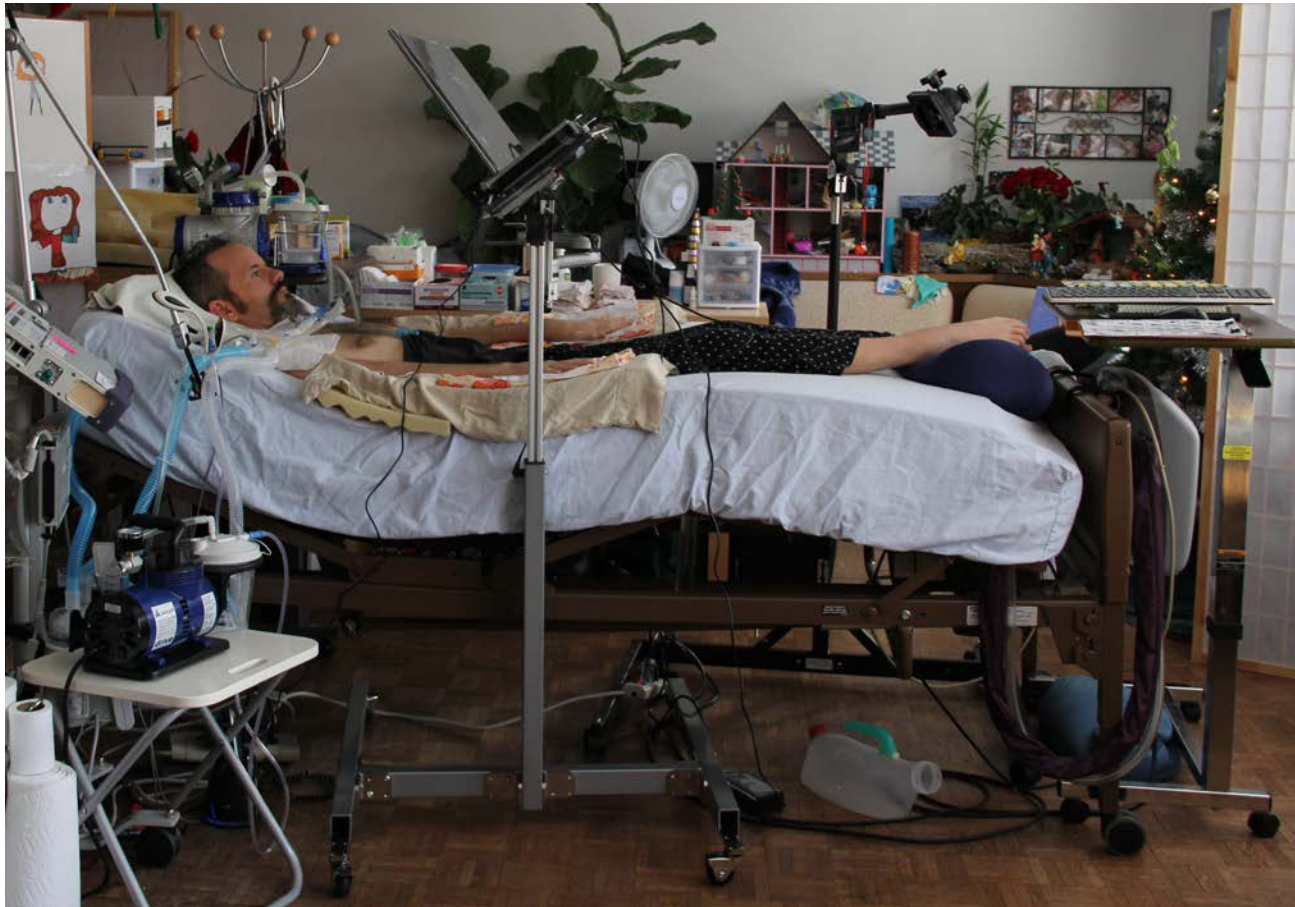

DJ David Rocks New Year's Eve



Is There Risk of Damage to the Device?

Can the device be moved out of the way rather than removed entirely risking damage and loss?

Securing device to a mount protects it from dropping.

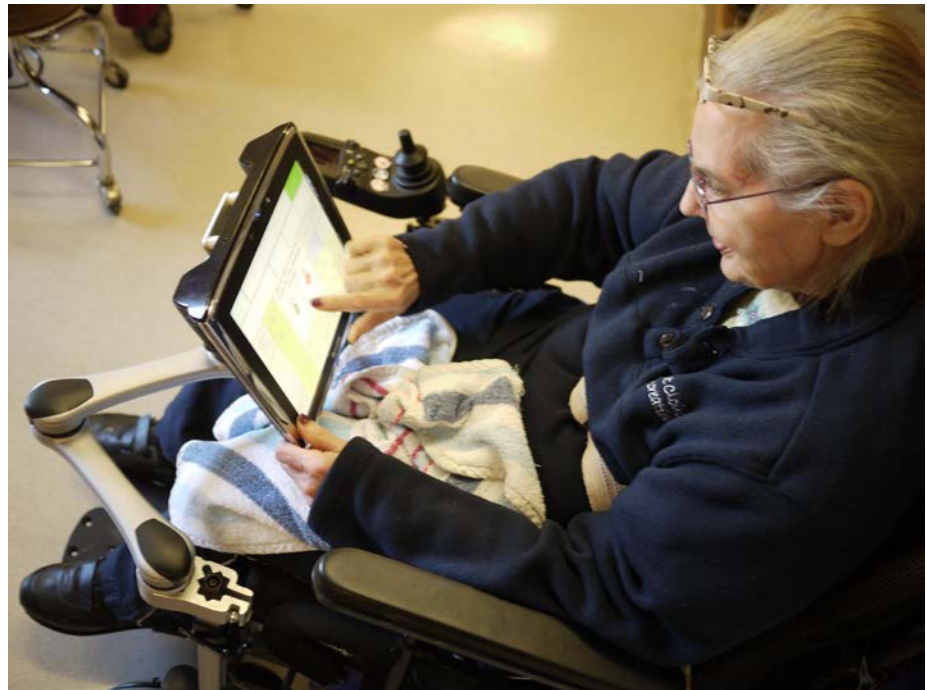

Protect Investment Move Instead of Remove

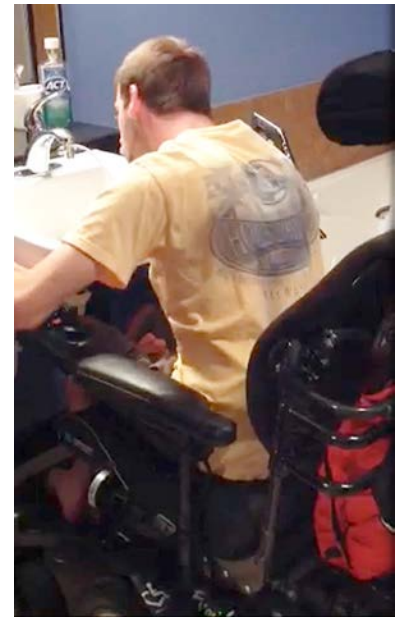

Ryan moves his device to the side allowing him to turn on the faucet for a drink.

Library or Workstation Access

- Universal Design for library or workstation
- Access from a chair, wheelchair or standing, or on the floor
- Access many different devices
- Secures device from damage
- Adjustable for different sizes and positions for good ergonomics

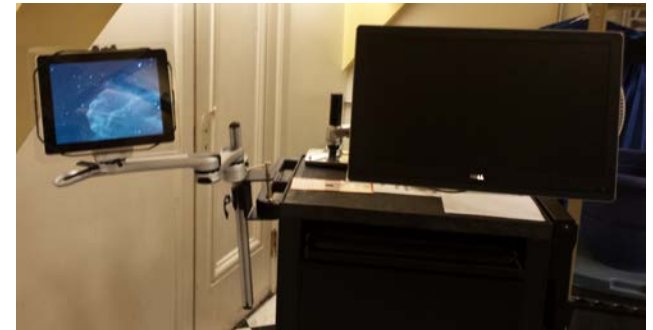

Ken

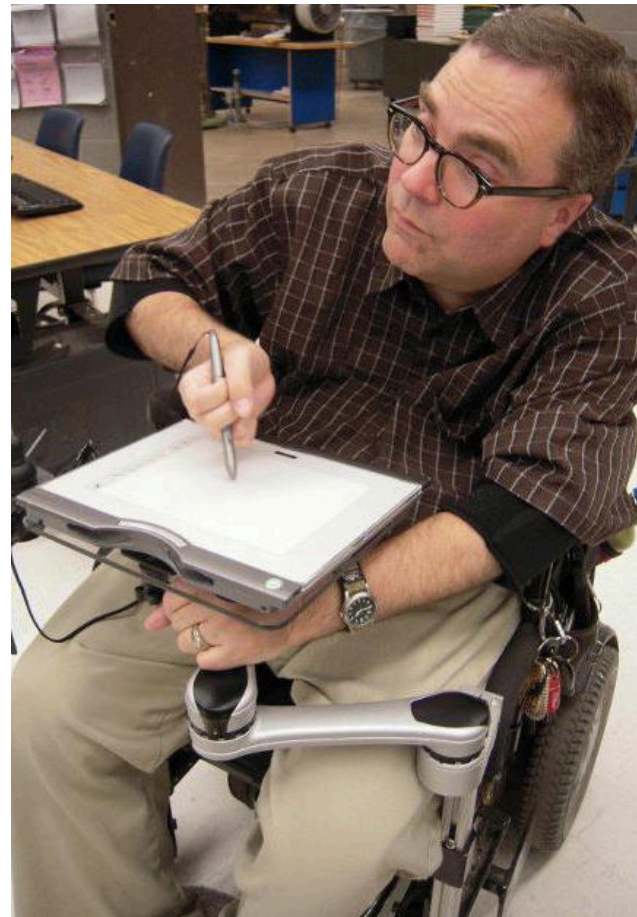

What Additional Health Benefits Does it Offer?

Optimal Positioning and Access Provides:

- Improved range of motion & fine motor dexterity with increase use due to access
- Improved access to sink and toilet (hygiene)
- Improved ability to eat (pull up to a table or positioning of tray)
- Improved ergonomics; less pain
- Ability to change positioning based on the activity
- Better head control due to device positioning (height & tilt)
- Less fatigue

Therapeutic Benefits

Better Access = Increase Use



Fine motor improved
since using iPhone due
to increase in use

Therapeutic Benefits Improve Posture



Positioning iPad
at eye level
improved posture

Therapeutic Benefits Improve Posture

Neck pain reduced
immensely after just
one week with
elevated.

BEL13VE in Miracles
Foundation



Psychosocial Benefits Of A Moveable Mount Reported

Study by Ithaca College OT Department

PIADS: How are you affected by the Mount' n Mover?

Adam Kinney, MS and Lynn Gitlow, PhD, OTR/L, ATP

"A Consumer-Centered Approach to Evaluating Assistive Technology Usability Outcomes"

June 2015 issue of American Occupational Therapy Association Special Interest Section on Technology.

Increase:

Competence

Adaptability

Self esteem

Decrease:

Frustration

Embarrassment

Confusion

Impacted more than device access, unrelated tasks were easier to perform. Tasks included: transferring, answering calls, socializing, feeding, shopping, and adaptive baseball.

Anecdotal outcome/case study: Kevin

Able to independently reposition it

Much improved access

Photos and videos

Crowd-sourced for funding

Speech improved - relaxed

Family impact

"I began comparing the idea of being without it to being in a manual wheelchair instead of my power chair" Kevin



Impact on Individual and Family

I have now had my own Mount'n Mover for a few weeks and have found myself *naturally doing things I couldn't before*.

We attended a small wedding, and I was *able to take several pictures of the ceremony and then email them to the couple* immediately afterwards.

I can change nearly every aspect of the position of the iPad *myself*, no needing to ask for help, no trying to explain to someone how I want it repositioned, *no waiting for someone to help*.

The security of having my iPad easily accessible for communication has *significantly increased my confidence and boldness* when I am around other people; this *makes my speech much clearer*

His wife said: He is able to *go out into public alone and I don't worry* about him communicating with others. He's now able to take our daughter on *daddy daughter dates* which both of them love.

Are there Safety Considerations?

Decrease tipping hazard by keeping device closer to the wheelbase of chair

Avoid obstructing vision when driving

Ability to move mount quickly out of the way in case of emergency (aspiration, seizure)

Can Additional Functional Needs be Met?

Can the mount assist with other functional needs

What do they want to do?

Functional Needs Music Class

Trumpet is mounted to support weight and raise into position



Functional Needs Eating

With optimal positioning of his plate, Jordan can feed himself for the first time!

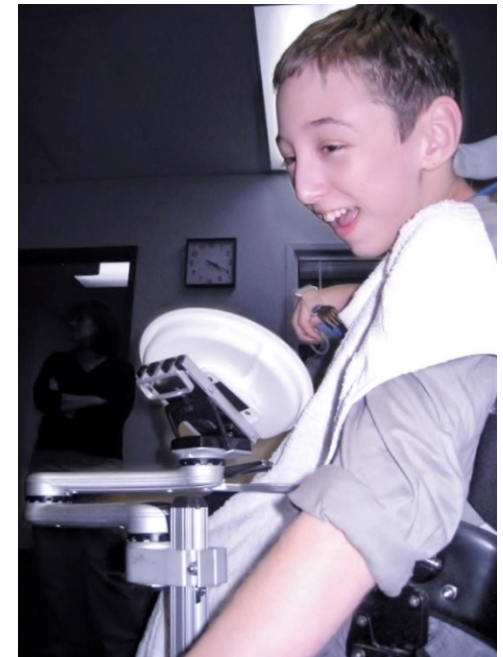

Functional Needs Think Outside the Box!

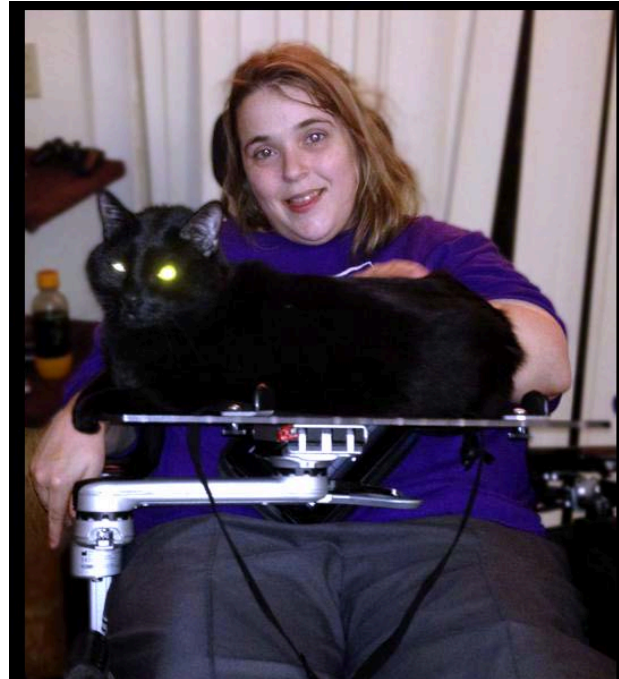

The Great Prom Adventure



How Can it be Used for Evaluations?

- Mount can allow for ease adjustments and is customizable for evaluations
- Ability to be quickly attached to a variety of surfaces, easily moved, and provide a stable set up for evaluations
- Consider using it during therapy sessions for working on range of motion, posture and visual access or testing



Assessment Questions

- Does it allow for daily adjustments for change in positioning, growth, fatigue, environment?
- Can the mount be used independently by the user?
- Does the mount allow access to a variety of items?
- Can it provide multiple operating positions without the use of tools?

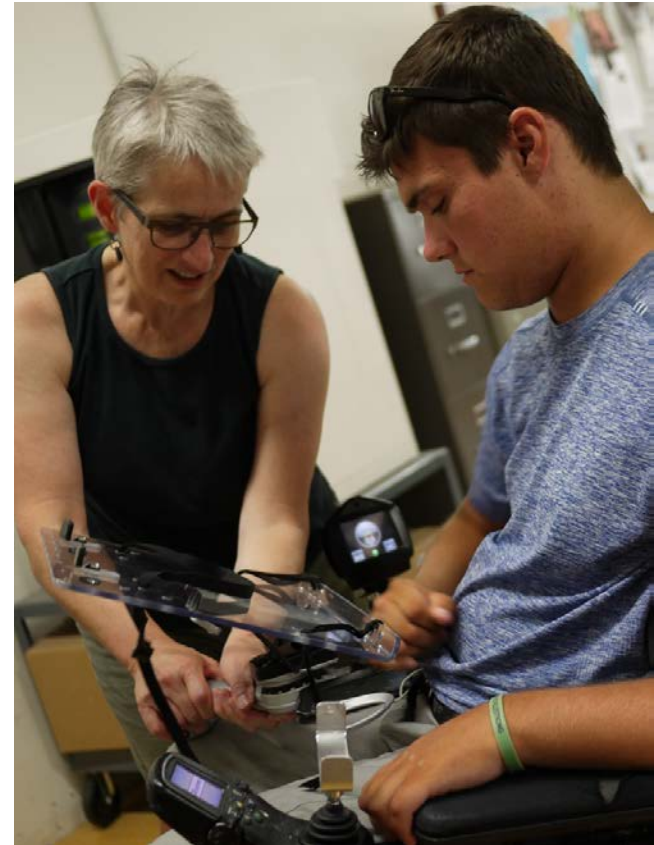

Assessment Questions Continued

- Does it enable independent access to a communication device in all situations and environments at all times?
- Can the device be moved out of the way rather than removed entirely risking damage and loss?
- Does the mount provide consistent positioning for specific locations?
- Can it be moved from chair to bed thus eliminating the need for 2 mounts?
- Does it help caregivers set up device?



Evaluation Kits



**Device Plate
Attachment Set**



**Eval Kit
includes Case**



Table Eval Kit

Support Tab Wheelchair Mounting Overview

Independence within reach! Log In | My Quote

Mount'n Mover
by BlueSky Designs

Enter your keywords

Products - Support - Resources - Community - About Us -

HOME > SUPPORT > WHEELCHAIR MOUNTING OVERVIEW

Wheelchair mounting overview

The diagram below shows how to mount to your wheelchair or other object. Click on hardware parts in the diagram to view specifications and install instructions. Click here to view a high-resolution version of the diagram (JPG).

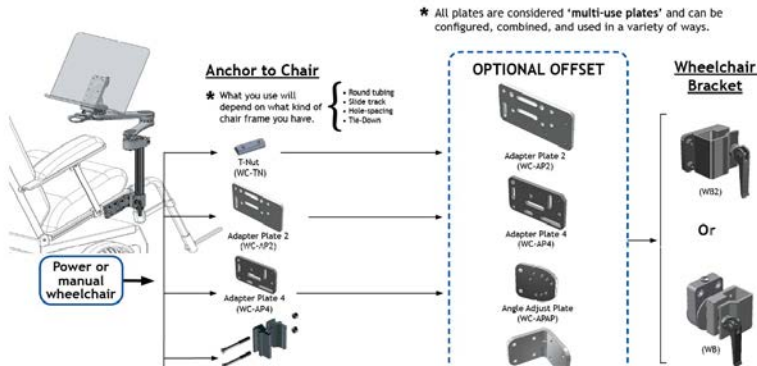

A) Choosing the right mounting hardware B) Selecting a wheelchair bracket

Offset options
Custom fabrication

Mount Location

Determine attachment location to suit end-use

Attaching to the seat rail minimizes post length and allows users to maintain access to devices at different tilt angles.

Seat-Rail: Use if mount needs to tilt with the seat.

Example:

A speech device tilts to allow communication from any angle



Select your wheelchair or other item below to see hardware recommendations and mounting instructions.

Brand/Model

- Select -

If you prefer that the mounted device does not tilt with a tilting wheelchair, attach to the sub-frame or base.

Frame-Rail: Use if mount must remain stable regardless of seat angle.

Example:

A tray for eating needn't tilt.



Mounting hardware by wheelchair type

Check out our mounting options list, where we have mounting guides for many wheelchairs, walkers and more.

We also have generic guides for various frame types, listed in the Mounting Guides menu.

Offsets and extensions

Mounting to a wheelchair can sometimes be tricky. There will be situations where

Slide Track Attachment

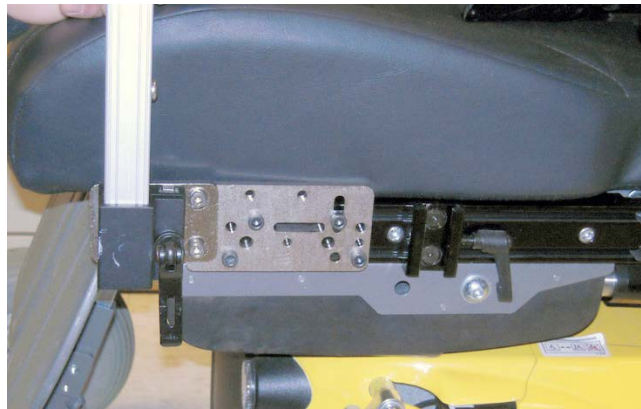

Bridge Clamp for Round Tubing

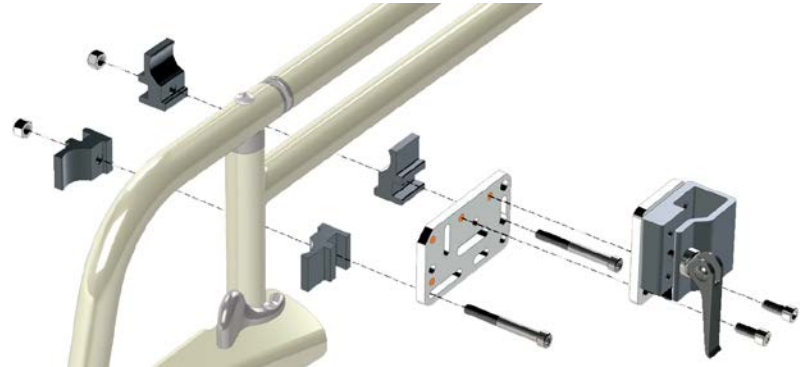
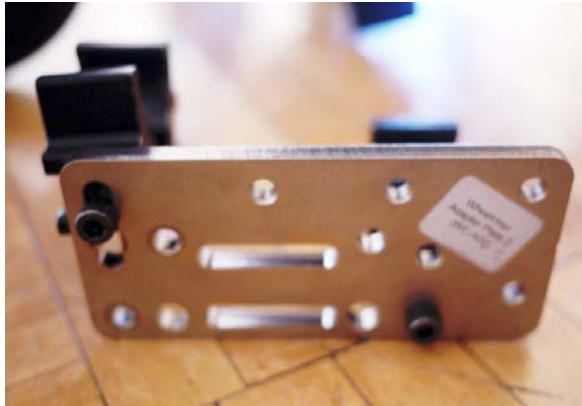

Evals, Trials and Warranties

- Evaluation Kits for loan through Meet the Mount'n Mover Program, 2 weeks, only cost is shipping
- 30 day return policy
- One year warranty
- Customer support in-person, email, phone, skype, Facetime...

Medical Justifications

Need to access from a tilted position

Improved visual access for driving

Positioning for access from more than one position (direct and eye gaze)

Able to quickly move the device

Hygiene: able to use a sink and toilet

Positioning changes, so device must change

Must adapt as abilities change (ALS, MD...)

Safety - keep chair from tipping

See: www.mountnmover.com/evaluate-buy/funding/

Letter of Necessity

- Provides independence through positioning and ease of use
- Allows for appropriate communication device position while the chair is tilted.
- provides (name) continuous access to their communication device in the event of an emergency
- Decreases tipping hazard
- Improved visual access for driving/wheeling
- Customized lock positions avoids caregiver guessing and frustration
- Provides access to technology/communication 24/7 in case of emergency

Web Site Resources Therapist Page

www.mountnmover.com/for-therapists-2/

- Funding information
- Research
- Videos
- Reviews
- And more!

Videos

As a result of a spinal cord injury, Rick has limited movement and strength. See how he does photography and more with the support of his Mount'n Mover mounting system.

https://www.youtube.com/watch?v=Goqh_XdQo6U

See how Gae finds ways to preserve her independence while living with ALS. <https://www.youtube.com/watch?v=4RH5IjYnQjU>

Check out Sophia, who has Spinal Muscular Atrophy (SMA) and uses eye gaze technology and her two Mount'n Mover to communicate, learn and interact with her classmates remotely!

https://www.youtube.com/watch?v=AGJK80_8jvM&feature=youtu.be

NCIS: New Orleans

Daryl Mitchell
(Patton Plame)



Future Developments

Pow!r Mount



Auto Repositioning

A mount that Auto-Repositions a speech device!



Out of position
(not calibrated)



Pow!r Mount repositions
(calibrated)

Rotates

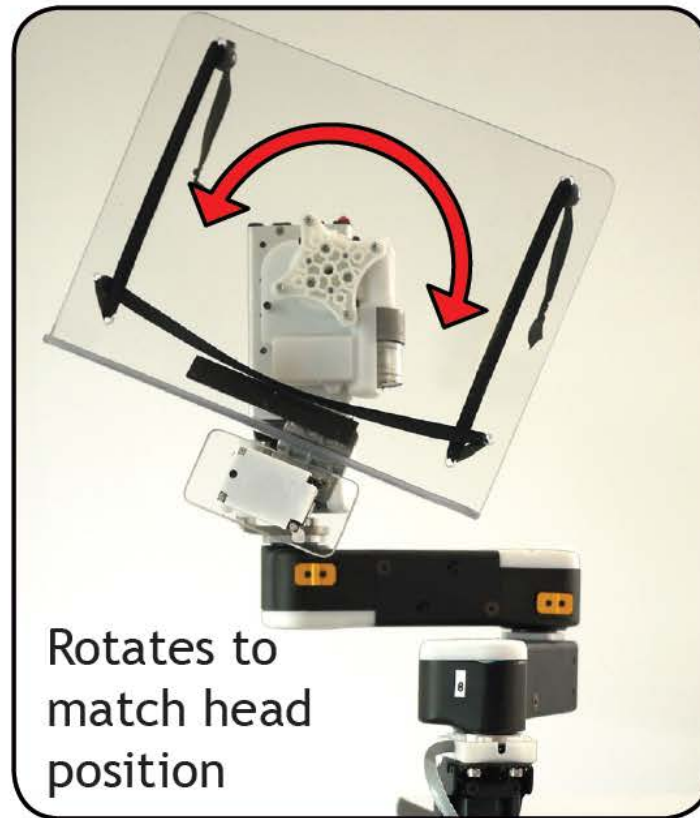

Rotates to
match head
position

BlueSky Dream Team



Thank you!

See mountnmover.com
for product support,
resources and more
information!

