

**Attaches to:** Rolltalk, Rolltalk IntelliGaze

Device (Rolltalk, and Rolltalk IntelliGaze) to device plate

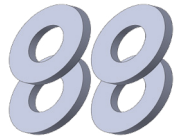

M4-.7 x 10mm (x4)  
3/8" OD x 1/16" HT (x4)

Quick release plate (QRP) to device plate



8-32 x 1/4" (x4)

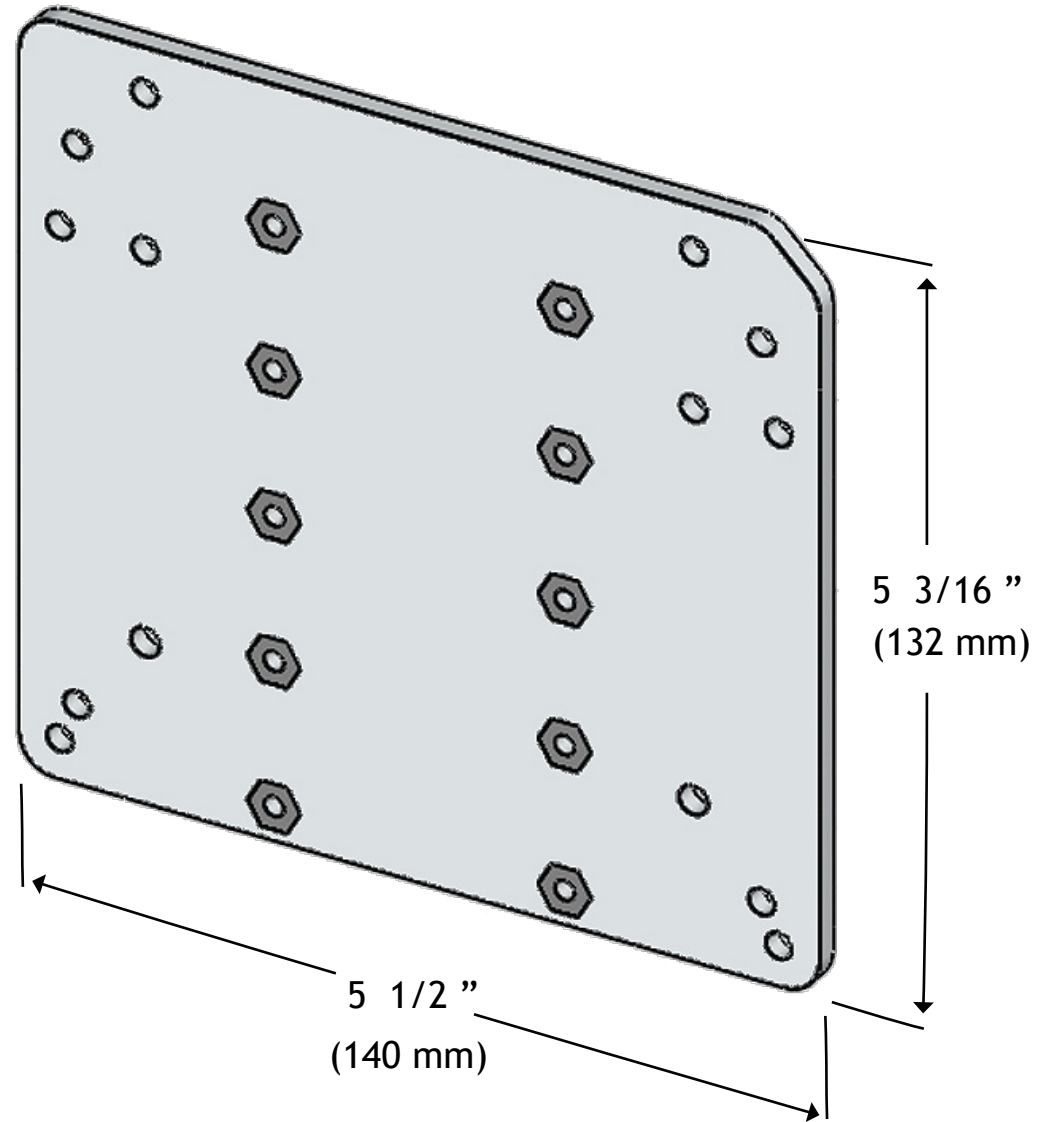

# RollTalk

Remove screws

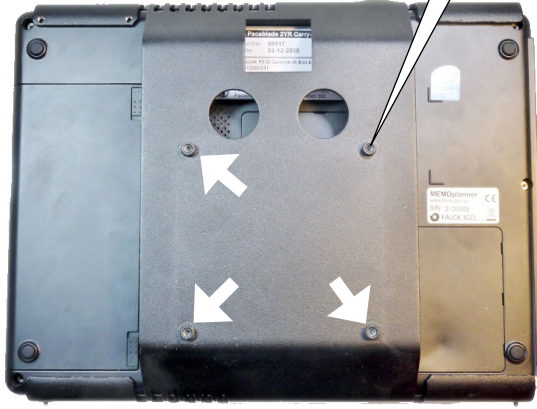

Device shown with original mounting plate

ATTACH PLATE

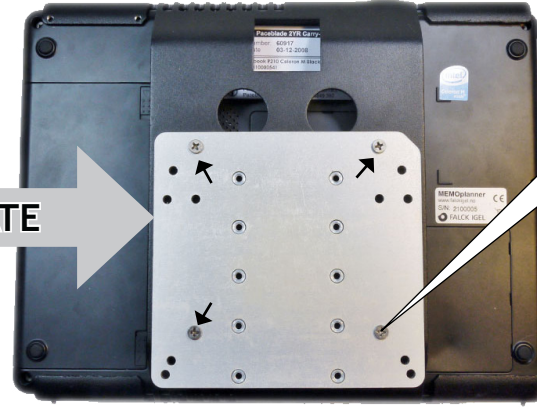

M4-.7 x 10mm  
x4

ATTACH QRP

x4  
8-32 x 1/4"

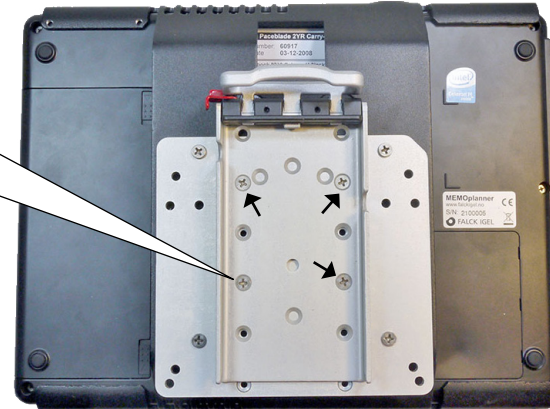

# RollTalk IntelliGaze

Remove screws

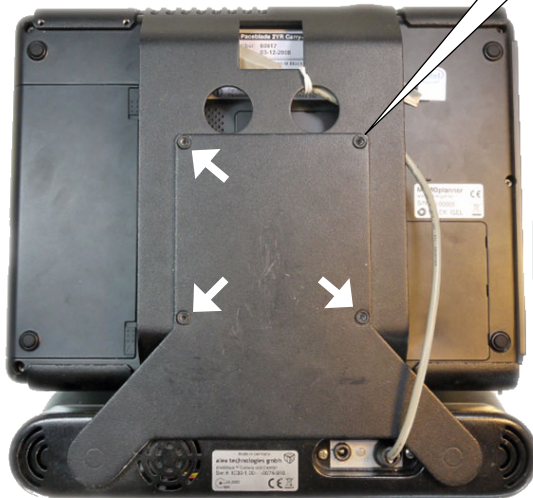

PLACE SPACERS

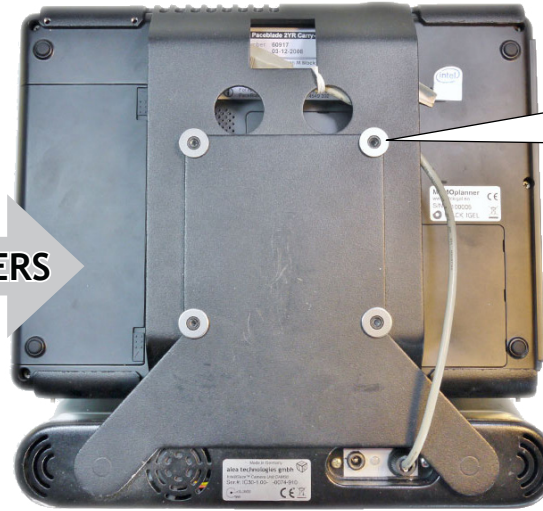

ATTACH PLATE

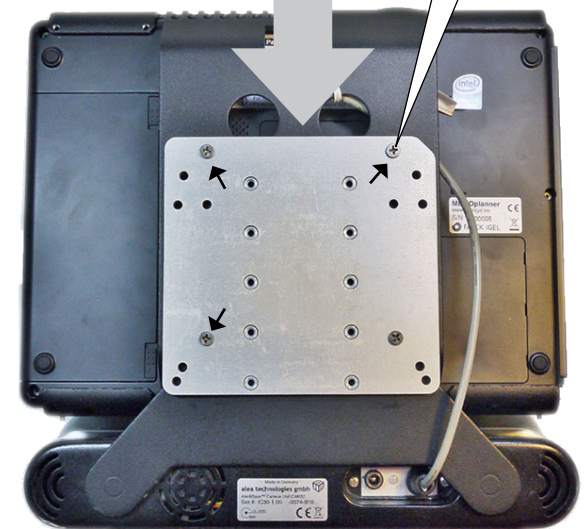

Device shown with original mounting plate

x4  
8-32 x 1/4"

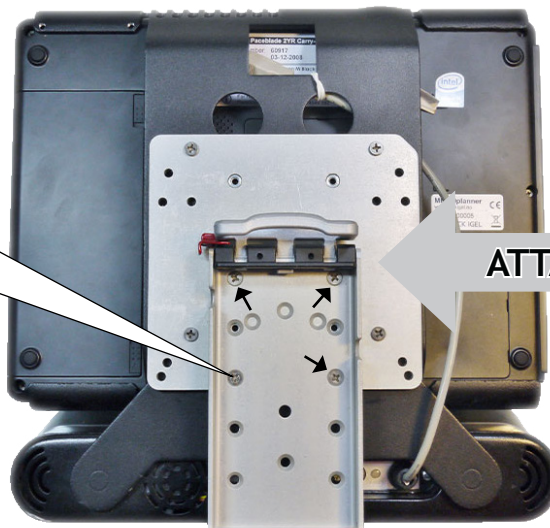

ATTACH QRP

Option

STAND + 90  
or  
ROTATOR  
(Attach before QRP)