

**Attaches to:** Mobi/Tellus

Mobi/Tellus  
to device  
plate

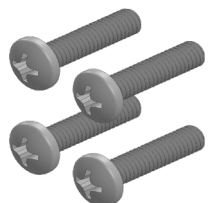

M4-.7 x 16mm (x4)

#8 ID x 3/8 OD x 1/8 HT (x4)

QRP to  
device plate

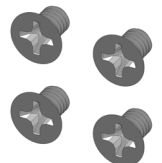

8-32 x 1/4" (x4)

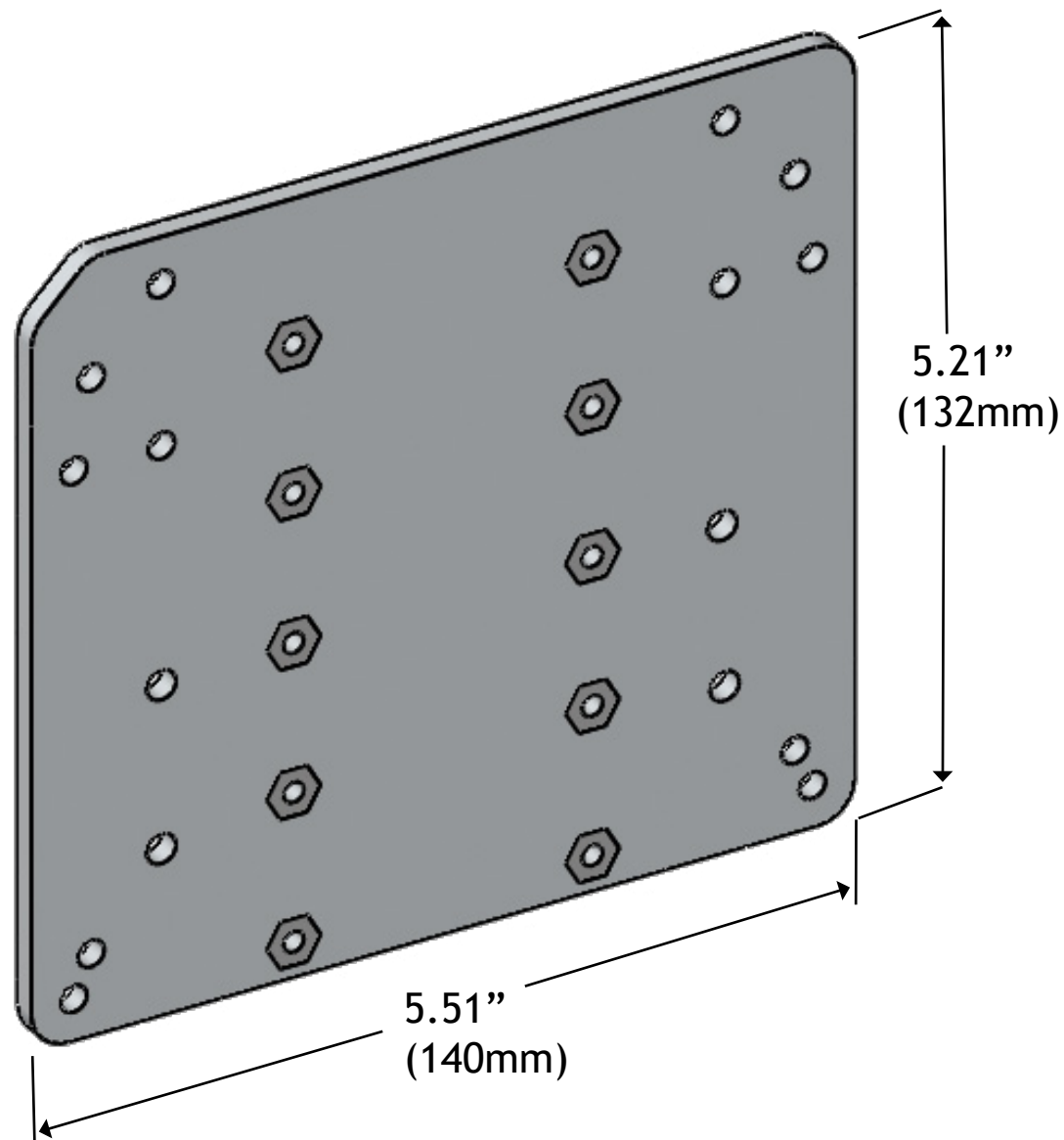



# Tellus

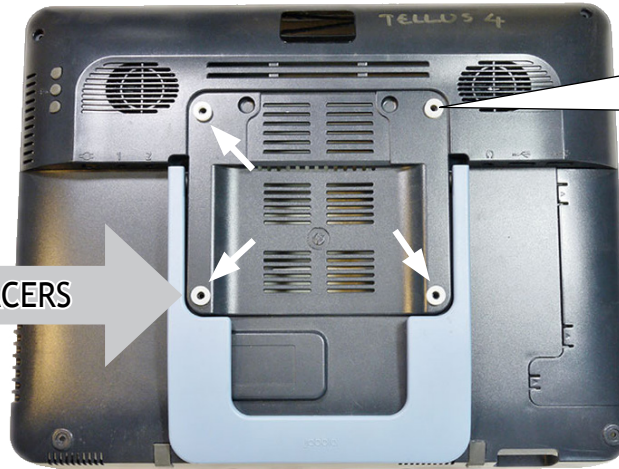

Initial device configuration

PLACE SPACERS



#8 ID  
x 3/8 OD  
x 1/8 HT  x4

ATTACH PLATE

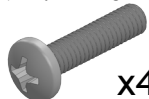
M4-.7 x 16mm  x4

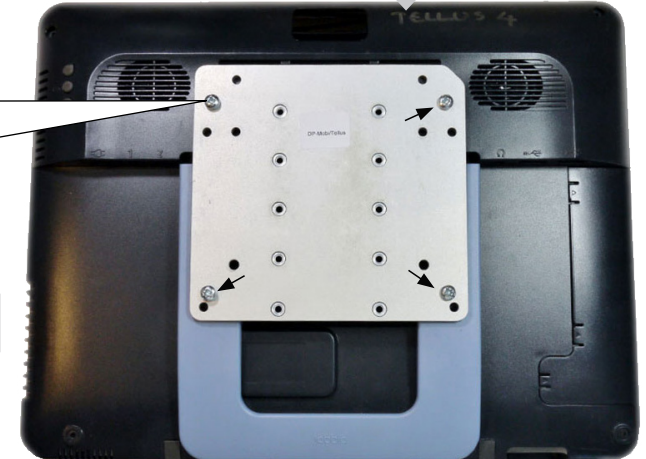

ATTACH QRP

x4  #8-32 x 1/4"

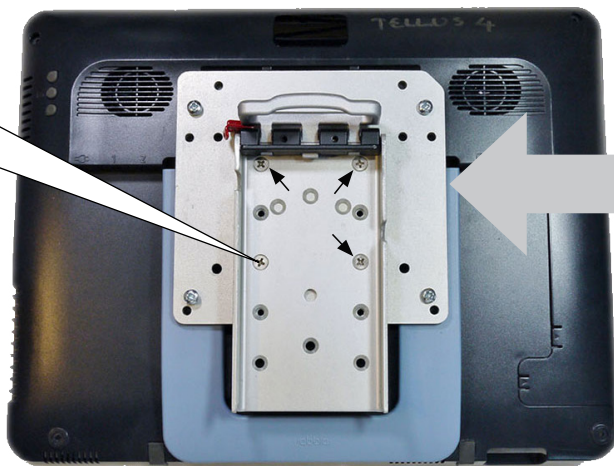

# Mobi

“Kickstand” has been removed

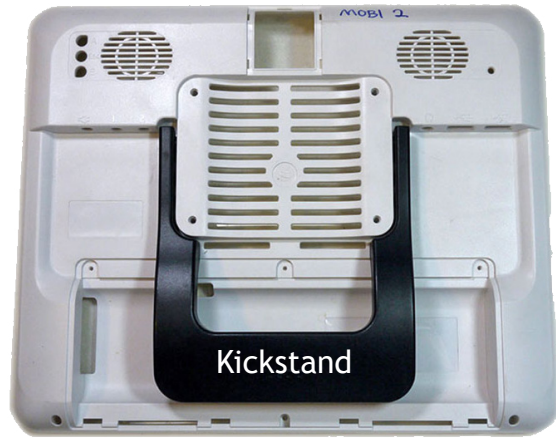

Initial device configuration

PLACE SPACERS

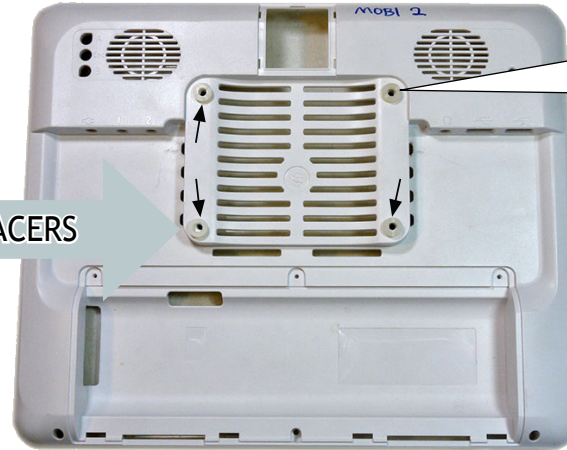

#8 ID  
x 3/8 OD  
x 1/8 HT  
x4

ATTACH PLATE

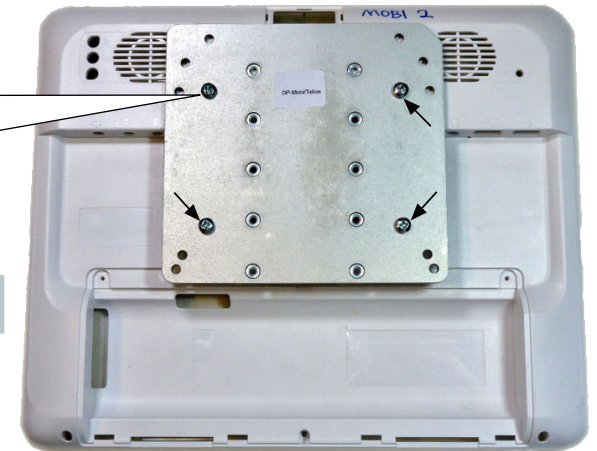

M4-.7 x 16mm  
x4

ATTACH QRP

x4  
#8-32 x 1/4"

